

# KOSMOS SERIE

CODE: 30727012 EDITION: 04-09-2006

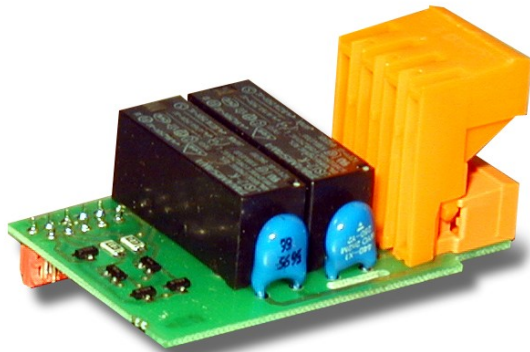

## INSTRUCTIONS MANUAL SETPOINT OUTPUT OPTION



2RE-4RE  
4OP-4OPP



DITEL 

# INTRODUCTION TO THE KOSMOS SERIES

**This manual does not constitute a formal agreement. All information given in this manual is subject to change without notice.**

The serie KOSMOS brings a new philosophy in digital panel instrumentation by using multipurpose, modular-concept devices providing a rich array of basic functions and advanced capabilities.

With a fully MODULAR DESIGN, it is possible to implement a wide variety of applications simply by adding the desired option(s).

Built-in intelligence allows the meter to recognize the options installed and implement the necessary parameters to properly function within desired parameters. The basic instrument without output options omits these data in the program routines.

CALIBRATION is performed at the factory eliminating the need for adjustment potentiometers. Any circuit or option liable to be adjusted incorporates a memory where calibration parameters are stored, making it possible the optional cards be totally interchangeable without need of any subsequent adjustments.

Custom CONFIGURATION for specific applications can be made quickly and easily through three or five front panel keys, following structured choice menus aided by display prompts at each programming step.

Other features of the KOSMOS family include :

- CONNECTIONS via plug-in terminal blocks without screws and CLEMP-WAGO clips cable retention system.
- DIMENSIONS  
Models ALPHA & BETA 96x48x120 mm DIN 43700  
Models JUNIOR, JUNIOR20, & MICRA 96x48x60 mm DIN 43700
- CASE MATERIAL UL-94 V0-rated poly-carbonate.
- PANEL INSTALLATION by means of single part fingertip without screws.

To guarantee the meter's technical specifications, it is advised to check calibration parameters at periodical intervals according to the ISO9001 standards for the particular application operating criteria.

Re-calibration of the meter should be made at the factory or in a qualified laboratory.

# OUTPUT OPTIONS

# 2RE – 4RE – 4OP – 4OPP

## INDEX

1 . GENERAL INFORMATION SETPOINTS OPTION.....	4
2 . SETUP AND CONNECTIONS	
2.1 - INSTALLATION.....	5
2.2 - CONNECTION.....	6-7
2.3 – TECHNICAL SPECIFICATIONS.....	7
3 . MODE OF WORKING	
3.1 – INDEPENDENT SETPOINTS.....	8-9
3.2 – ASSOCIATED SETPOINTS.....	9
3.3 – AUTO-TRACK.....	10
4 . PROGRAMMING	
4.1. – MODELS MICRA.....	11-12-13-14-15-16
4.2. – MODELS ALPHA.....	17-18-19-20-21-22
4.2. – MODEL BETA-M.....	23-24-25-26-27-28-29-30-31-32

# 1. SETPOINTS OPTION

An option of 2 or 4 SETPOINTS, programmable within the full display range, can be incorporated to the unit thus providing alarm and control capabilities by means of individual LED indicators and relay or transistor outputs.

All the setpoints provide independently programmable value, time delay (in seconds), asymmetrical or symmetrical hysteresis (in counts of display) and selectable HI/LO acting.

The setpoints are also configurable to activate independently (each one activates at its corresponding programmed value) or tracking one another (setpoint 2 can be conditioned by the action of setpoint 1, setpoint 4 by setpoint 3). Such latter function is included in the programming menus with the name of "TRAC" and, in case of the setpoint 2, it can be manual or automatic.

The setpoint option consists of a plug-in additional card that once installed to the meter's main board, activates its own programming module. The setpoints programming may be locked out by means of DIP-switches located on the main board to prevent from accidental or unauthorized changes. The available alarm/setpoint output options are the following:

**2RE:** 2 SPDT relays rated 8A

**4RE:** 4 SPST relays rated 5A\*

**4OP:** 4 isolated open-collector transistors NPN

**4OPP:** 4 isolated open-collector transistors PNP

These type of outputs, capable of carrying out a wide variety of control operations and processing of limit values, increases notably the unit's performance qualities thanks to the possibility of combining basic alarm functions with advanced safety and control applications.

\* from n° O5397

## 2. SETUP AND CONNECTIONS

### 2.1 INSTALLATION

Lift out the electronics assembly from the case and use a screw-driver to push on the junctions between the case and the shadow areas to detach them from the case. See fig1.

The so performed orifice will allow any of the setpoints board output connectors be brought out at the rear of the instrument.

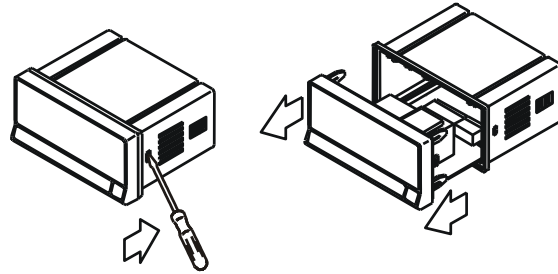

The option is installed by plugging the connector in the main board location as shown in fig. 2 .

Insert the card pin in the corresponding main board slot (see figure) and push down to attach both connectors.

If the instrument is to be installed in high vibrating environments, it is recommended to solder the card to the main board making use of the copper tracks on both sides of the card pin and around the main board hole on its solder side.

Before inserting the electronics in the case, you should verify that the access to the setpoints programming module is enabled, as this is the first operation to be made once the instrument is powered up.

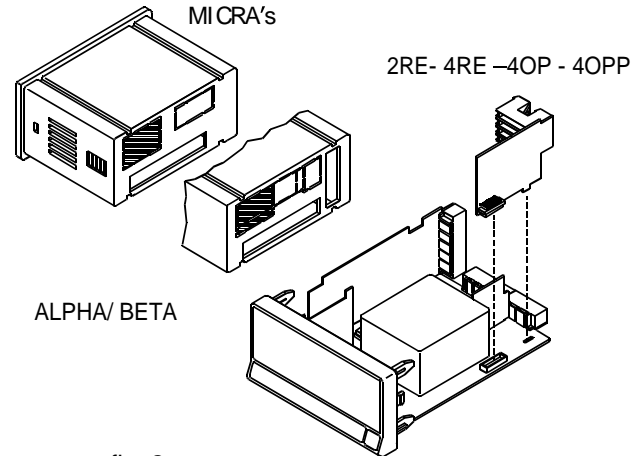

fig. 2

## 2.2 - CONNECTION

**NOTE :** In case that the outputs are used to drive inductive loads, it is recommended to add an RC network between the coil terminals (preferably) or between the relay contacts to limit electromagnetic effects.

### LCIA-01 - 2 RELAYS OPTION

PIN 4 = N. Open 2	PIN 1 = N. Open 1
PIN 5 = COMMON 2	PIN 2 = COMMON 1
PIN 6 = N. Closed 2	PIN 3 = N. Closed 1

### LCIA-02 - 4 RELAY OPTION

PIN 4 = RL4	PIN 1 = RL1
PIN 5 = Non connected	PIN 2 = RL2
PIN 6 = COMMON	PIN 3 = RL3

### LCIA-03 - 4 OPTOS NPN OPTION

PIN 4 = OP4	PIN 1 = OP1
PIN 5 = Non connected	PIN 2 = OP2
PIN 6 = COMMON	PIN 3 = OP3

### LCIA-04 - 4 OPTOS PNP OPTION

PIN 4 = OP4	PIN 1 = OP1
PIN 5 = Non connected	PIN 2 = OP2
PIN 6 = COMMON	PIN 3 = OP3

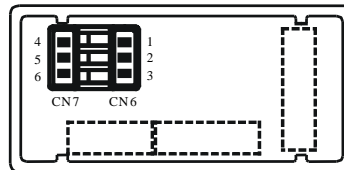

Fig. 6.1: Rear view of basic instrument with Relay / Opto output option.

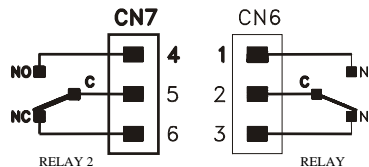

Fig. 6.2: Connection diagram for 2RE

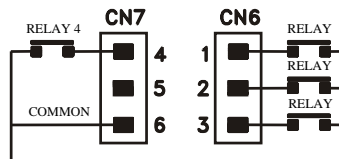

Fig. 6.3: Connection diagram for 4RE

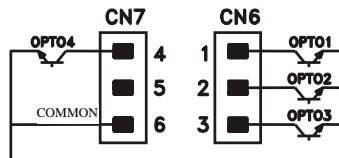

Fig. 6.4: Connection diagram for 4OP

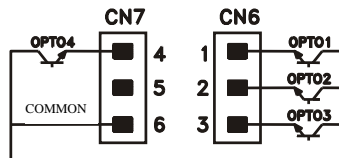

Fig. 6.5: Connection diagram for 4OPP

## INSTALLATION

To meet the requirements of the directive EN61010-1, where the unit is permanently connected to the mains supply it is obligatory to install a circuit breaking device easy reachable to the operator and clearly marked as the disconnect device.

### WARNING

In order to guarantee electromagnetic compatibility, the following guidelines for cable wiring must be followed:

- Power supply wires must be routed separated from signal wires. Never run power and signal wires in the same conduit.
- Use shielded cable for signal wiring and connect the shield to ground of the indicator (pin2 CN1).
- The cable section must be  $\geq 0.25 \text{ mm}^2$

**If not installed and used according to these instructions, protection against hazards may be impaired.**

## CONNECTORS

To perform wiring connections, remove the terminal block from the meter's connector, strip the wire leaving from 7 to 10mm exposed and insert it into the proper terminal while pushing the fingertip down to open the clip inside the connector as indicated in the figure.

Proceed in the same manner with all pins and plug the terminal block into the corresponding meter's connector.

Each terminal can admit cables of section comprised between  $0.08 \text{ mm}^2$  and  $2.5 \text{ mm}^2$  (AWG 26 ÷ 14).

The blocks provide removable adaptors into each terminal to allow proper fastening for cable sections of  $< 0.5 \text{ mm}^2$ .

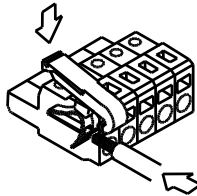

## 2.3 – TECHNICAL SPECIFICATIONS

### 2RE OPTION

- Max. current (resistive load) ..... 8 A
- Max. Power..... 2000 V @ 192 W
- Max. Voltage..... 250 V AC/ 150 V DC
- Contact resistance..... max. 3 m $\Omega$
- Switching time .....max. 10 ms

### 4RE OPTION

- Max. current (resistive load) ..... 5 A
- Max. Power..... 1250 V A/ 150 W
- Max. Voltage..... 277 V AC/ 125 V DC
- Contact resistance.....max. 30 m $\Omega$
- Switching time .....max. 10 ms

### 4OP OPTION

- Max. Voltage..... 50 V DC
- Max. current ..... 50 mA
- Leakage current ..... 100  $\mu\text{A}$  (max.)
- Switching time ..... 1 ms (max.)

### 4OPP OPTION

- Max. Voltage..... 50 V DC
- Max. current ..... 50 mA
- Leakage current ..... 100  $\mu\text{A}$  (max.)
- Switching time ..... 1 ms (max.)

**All options are opto-isolated with respect to the input signal and main supply.**

### 3. METHODS OF OPERATION

#### DESCRIPTION OF OPERATION

All the setpoints can operate independently or in association with another in a variety of combinations to suit specific operating conditions.

#### 3.1 INDEPENDENT SETPOINTS.

As programmed like independent setpoints, the alarm outputs activate when the display value reaches the user-programmed value. The independent alarms programming requires definition of the following basic parameters :

##### a. HI/LO ACTING MODE.

In HI mode, the output activates when the display rises above the setpoint level and in LO mode, the output activates when the display falls below the setpoint.

##### b. PROGRAMMABLE TIME DELAY or HYSTERESIS.

Each output action can be deferred by a programmable time delay or hysteresis level.

The time delay is the time that takes the output to activate after passing through the setpoint in the up or down direction, while the hysteresis band can be selected asymmetrical (only acts on the output deactivation edge) or symmetrical (operates on both sides of the setpoint). The time delay can be set from 0 to the maximum displayable value in seconds and can have a decimal place. The hysteresis can be programmed, in counts, within the full display range. The decimal point appears in the same position as programmed in the display configuration module.

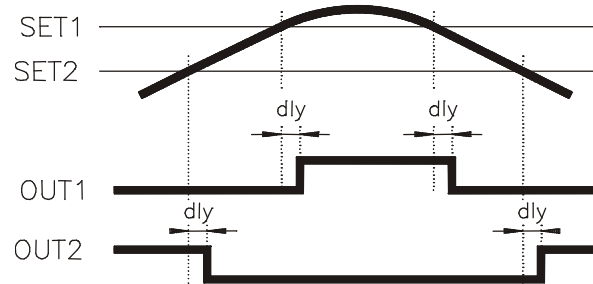

Fig. 1 Delay action (dly)

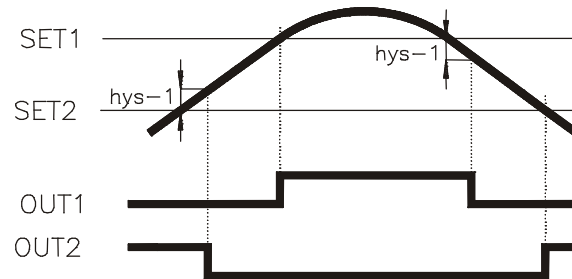

Fig. 2 Asymmetrical hysteresis



The figure 1 shows the action of the symmetrical hysteresis. In order to clarify the drawing, it has been represented one only alarm in the cases of HI and LO acting. The 100% of the programmed hysteresis (hys-2) is added to each side of the setpoint, thus creating a band around the setpoint within which the output is activated (mode HI) or deactivated (mode LO). This band can be as large as twice the maximum number of counts of the display.

The hold up of the alarm action by means of this type of hysteresis can be useful in operations in which it is necessary to keep the alarm condition between two specified points.

As an example, let's suppose that it is wanted to control a quantity composed of two other in proportion of 1000 and 2000kg. By programming the first setpoint at 500 with hys-2 = 500 and the second setpoint at 2000 with hys-2 = 1000, the alarm output should control the first quantity from 0 to 1000 and the second quantity from 1000 to 3000.

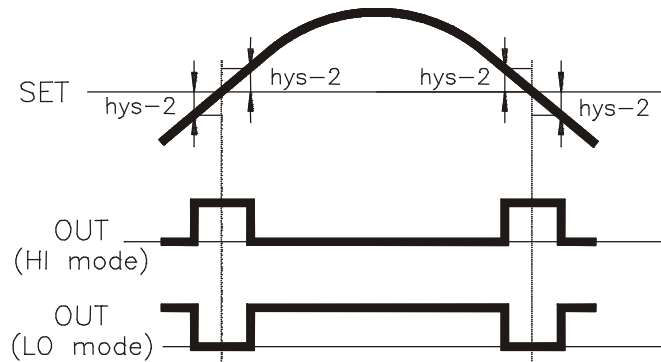

Fig 1. Symmetrical hysteresis

### 3.2 ASSOCIATED SETPOINTS

The SET2 and SET4 setpoints can be programmed to "track" SET1 and SET3 respectively. This type of alarms does not activate as compared with a preprogrammed display value but at a programmable fixed distance from the activation of their pre-alarms.

The programming of these alarms requires to determine first the pre-alarm setpoint value (for example SET1 = 200). Then, instead of programming the SET2, it is assigned an offset between this and the first alarm (for example TRACK2 = 50). Although SET1 is changed, the alarm 2 (if not changed) will always activate 50 counts above SET1. If a negative tracking value should have been programmed (-50), the alarm 2 would activate 50 counts below the SET1. The figure .2. shows an example of positive (TRACK2) and negative tracking (TRACK4).

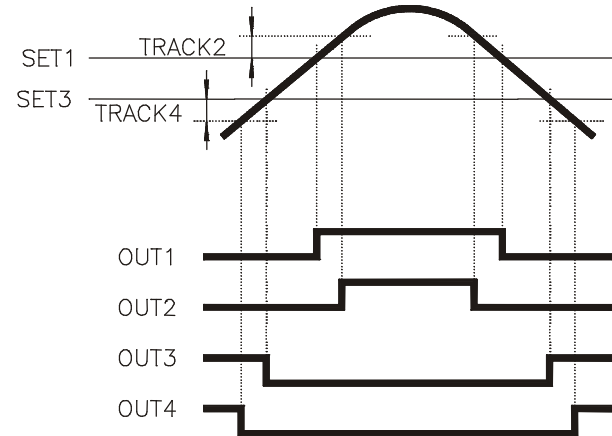

Fig 2. Tracking setpoints

### 3.3 AUTO-TRACK

In some measurement systems and particularly in weighing and dosage applications, the mechanical parts and the system structure makes it impossible to shut off operations at a given point (due to response times, weight in fly ...) this causing an extra quantity of material be settled after the interrupting action.

As an application example of the "AUTO TRACK" function, let's comment the effect known as "weight in fly". The "weight in fly" effect is produced in those systems in which some kind of recipient is to be filled with a preprogrammed quantity of material. Each time this quantity is reached, an alarm output stops the filling mechanism. However, the quantity of material which is still on air at the moment of shutting off the process, is deposited in the recipient exceeding from the desired measure.

The automatic track function (AUTO TRAC) is specially designed to compensate for this out of limit quantity.

This function is based on controlling the quantity in which the programmed limit is surpassed and using this excess to activate the shut off signal so that, including the out of limit quantity, the final measure suits the desired value.

Only the alarm 2 provides automatic track function. The auto tracking is implemented by programming SET1 for the desired limit value and SET2 for "AUTO TRAC" operation (initially it takes the same value as SET1).

SET1 = Desired setpoint value  
SET2 = AUTO TRAC

When, despite the alarm that shuts off the process activates, still a little quantity of material exceeding from SET1 is deposited, the excess is registered in the peak memory as "TRAC" value and subtracted from SET2.

This way, in successive measurements the output of SET2 will take charge of interrupting the operations one moment before the display reaches the programmed value. The extra quantity will then complete the measure until the required level.

We remark that the track value is continuously updated according to process needs.

## 4.1 MODELS MI CRA SETPOINTS PROGRAMMING

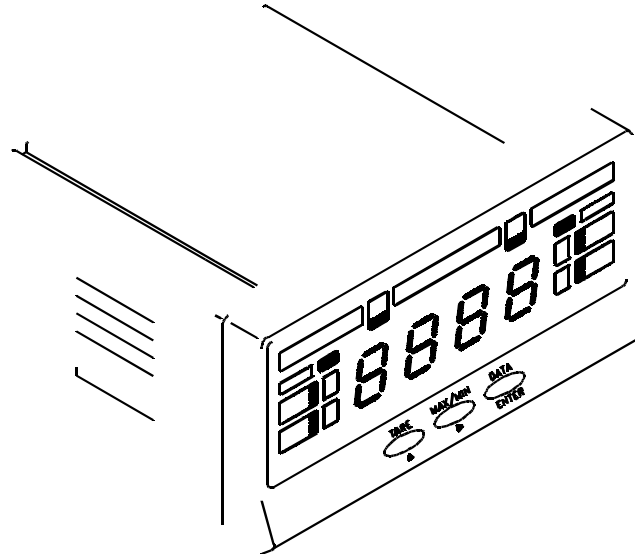

# MICRAS MODEL PROGRAMMING INSTRUCTIONS

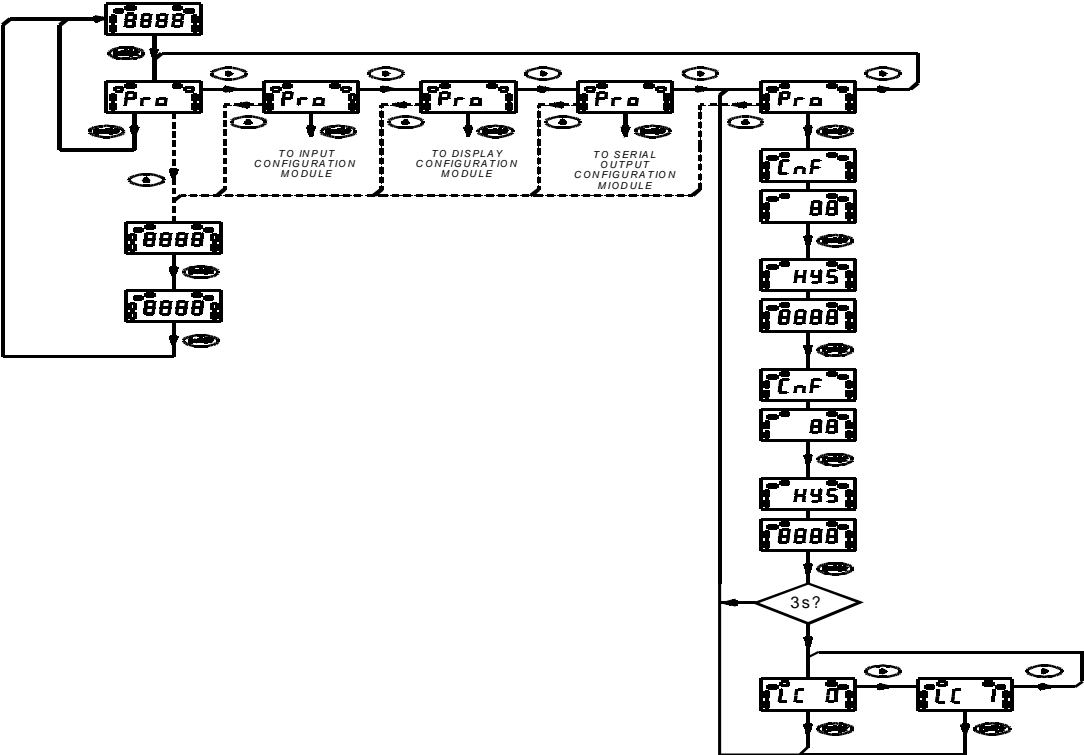

## SETPOINTS PROGRAMMING MODULE

### DESCRIPTION

The diagram represented on page 12 shows the setpoints programming module, which is valid for the MICRA models with 2RE option.

Apart from the setpoint values, this option permits the user to program the following parameters :

- The relays control mode ("HI" for activation above the setpoint or "LO" for activation below the setpoint)

- The action mode (time delay or asymmetrical hysteresis ).

- The amount of time delay in seconds or hysteresis in counts of display.

### ACCESS TO THE PROGRAMMING OF THE SETPOINT VALUES

The setpoints values are directly accessible from the **Pro** stage in any of the programming modules

From the run mode, press "ENTER" to get access to the programming mode. Press "" and leave it to enter in the first setpoint programming phase.

### ACCESS TO THE CONTROL MODE PROGRAMMING

From the run mode, press "ENTER" to access to the programming routines ; the display will show **Pro** and the **PROG** LED will activate. Press repeatedly the "" key until the **SET1** and **SET2** LED's activate.



A press of "ENTER" at this point provides access to the programming of various options as indicated on page 31.

This programming routine can be locked out (refer to the instrument instructions manual).

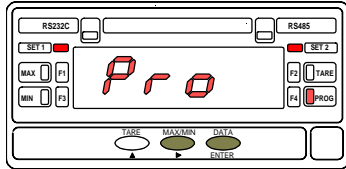
# SETPOINTS PROGRAMMING MENU



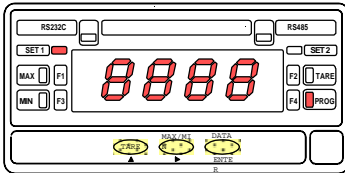

The setpoint values change can always be accessed from any of the **Pro** levels even if the programming routines are locked out.

The figure 14.1 shows the **Pro** indication, where the  key provides access to the programming modules or, a press of  returns the meter to the normal operation. To get access to the programming of the setpoint values, press the  key from this stage (or from any other with **Pro** indication).



A press of  made at previous step presents on display the current value for the setpoint 1 with the **SET1** LED activated and the last digit in flash.

If you desire to change the flashing digit value, press repeatedly the  key to rotate from 0 to 9 and, once the digit has taken the desired value, press to move to the next digit to be modified. Repeat these operations until the required value  for the setpoint 1 is registered on the display and press  to validate the entry and pass to the next program step.

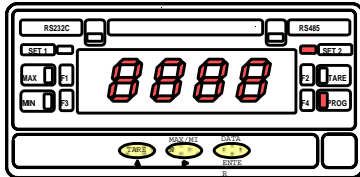



After, the initial value for the setpoint 2 appears on display (the **SET2** LED activates) with the last digit in flash.

Proceed as in the previous section :  changes the value of the active digit and  advances to the next digit to be modified.

Once the desired value is composed on the display, a press  of will return the meter to the run mode saving the programmed parameters.

# SETPOINT CONFIGURATION

If a two relay option is installed the instrument will allow to enter on the following routines: activation mode, delay or hysteresis and setpoint program lockout.

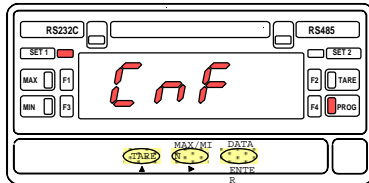

From programming mode (Pro stage, see fig. 15.1), press  key to access to the setpoint configuration, indication "SET". To program the setpoint numerical values, from the run mode press  to call the **Pro** stage and press  to access the first setpoint value.

## [15.1] Setpoint 1 Configuration



LEFT DIGIT VALUE	RIGHT DIGIT VALUE
MODE HI=0	DELAY=0
MODE LO=1	HYSTERESIS=1





The indication shown in figure 15.1 appears on the display to indicate that the next step is to program the setpoint1 operating parameters (led Setpoint 1 activated). After 2 seconds or by a press , the meter allows access to this menu.

The display then shows two digits: the leftmost one corresponds to the output mode (HI or LO) and the rightmost one corresponds to the delay unit (time -delay- or counts of display -hysteresis-) according to the table below the figure. Use the  key to change the active digit value (in flashing) and the  key to go to the next digit to be set.

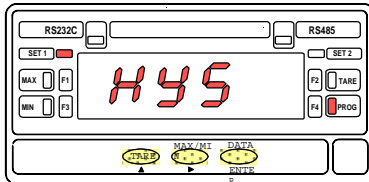
Press  to validate selections and advance to the next phase.

## [15.2] SET2 Hysteresis/Delay



Depending on previous phase choice, the display will show for 2 seconds the indication corresponding to the selected delay units before giving access to the time delay or hysteresis magnitude programming (**dLY**) or (**HYS**). After 2 seconds or by a press of , the initially programmed numerical value appears on the display with the first digit in flashing. To program the desired value (from 0 to 9999 counts of hysteresis or from 0 to 99 seconds of time delay) use the  key to increment the active digit value and the  key to advance to the next digit to be modified. Repeat this procedure until desired value is completed on the display and press  to validate and access to the programming of the setpoint 2 parameters.

## [16.1] Setpoint 2

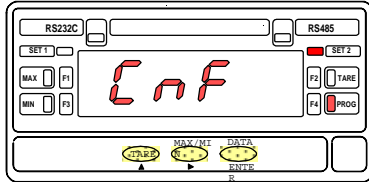

LEFT DIGIT VALUE	RIGHT DIGIT VALUE
MODE HI=0	DELAY=0
MODE LO=1	HYSTERESIS=1

The indication shown in figure 16.1 appears on the display to indicate that the next step is to program the setpoint 2 operating parameters (led Setpoint 2 activated). After 2 seconds or by a press **ENTER**, the meter allows access to this menu.

The display then shows two digits; the one on left corresponds to the output mode (HI or LO) and the rightmost one to the delay unit (time -delay- or counts of display -hysteresis-). See table in figure 16.1. Use the **▲** key to change the active digit value (in flashing) and the **▶** key to go to the next digit to be modified.

Press **ENTER** to validate changes and advance to the next phase.

## [16.2] SET2 Histeresis/Delay

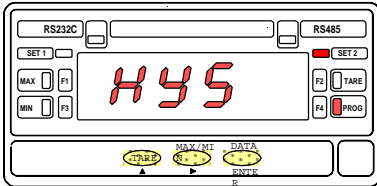

The display shows for 2 seconds the indication corresponding to the selected delay units before giving access of the time delay or hysteresis magnitude programming (**dLY**) or (**HYS**). After 2 seconds or by a press **ENTER**, the initially programmed numerical value appears on the display with the first digit in flashing. To change the value (from 0 to 9999 counts of hysteresis or from 0 to 99 seconds of time delay) use the **▲** key to increment the active digit value and the **▶** key to advance to the next digit to be modified. Repeat this procedure until desired value is completed on the display and press **ENTER** to validate and advance to the next step.

## [16.3] Setpoint Program lockout

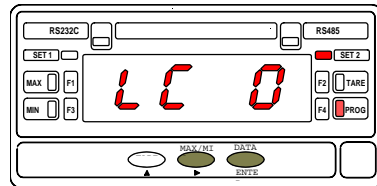

The figure 16.3 shows one of the two options available at this stage [**LC 0** = setpoint values programming enabled (unlocked) or **LC 1** = setpoint values programming disabled (locked)].

If wanted to modify this parameter, use the **▶** key to switch to the desired option. If you decide to lock the setpoint values, it will be also necessary to lock out the entire program routines.

Press **ENTER** to validate the choice, save programmed data and return to the run mode (indication **Stor**).



## 4.3 SETPOINTS PROGRAMMING MODELS ALPHA

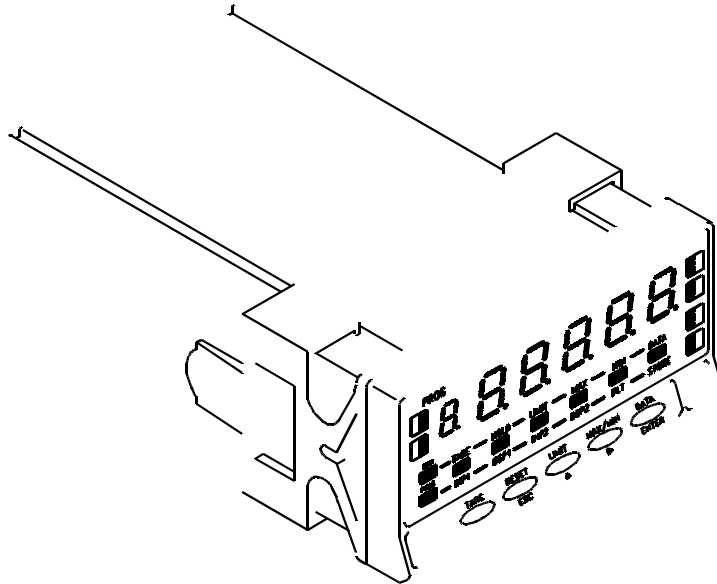

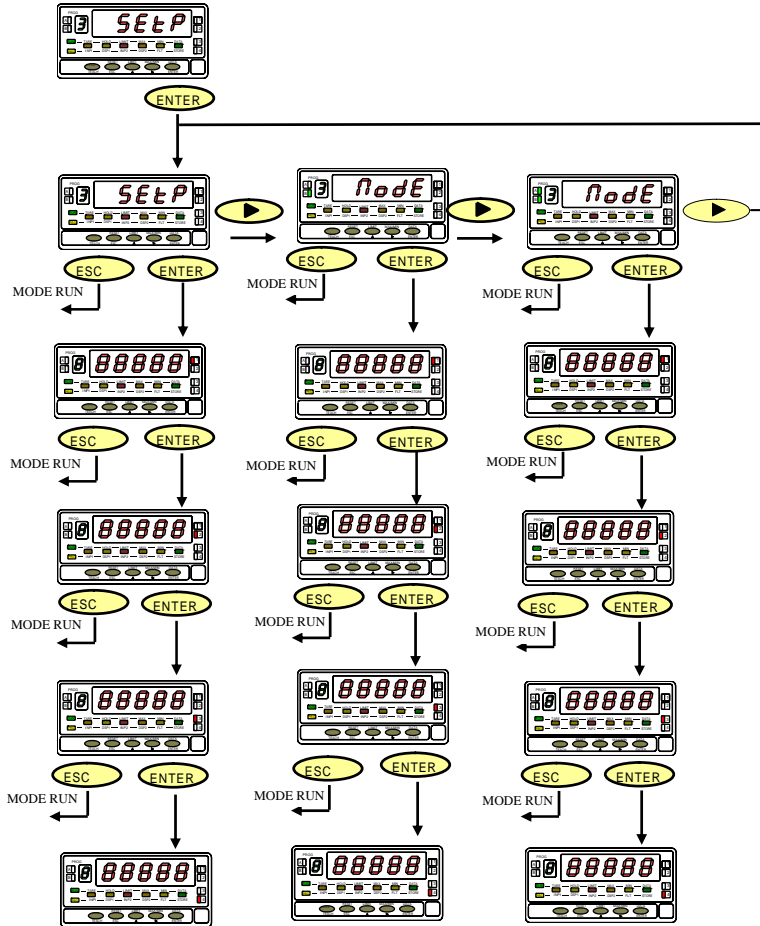

## MODULE 3 - SETPOINTS

### DEFINITION

The left diagram shows the entire MODULE 3 that allows to program the alarm/setpoint operation and is activated when one of the following output options 2RE-4RE-4OP-4OPP are installed.

Each one of the three menus is dedicated to a specific configuration parameter and is composed of four levels corresponding to each four of the setpoints (in case that a 2-relay option (2RE) is installed, only the first two levels will appear in the routines).

The configuration of the parameters relating one of the setpoints is made in a single step of each menu. The LEDs 1, 2, 3 and 4 illuminate by turn as the program advances one step of the menu, to indicate which of the setpoints is being treated at each time.

At the end of a complete sequence, a press of "ENTER" causes deactivation of all the LED indicators except "PROG" and activates the "STORE" LED for a few seconds. The programmed data is stored in the memory and the instrument returns to the reading of the variable under measure.

# ACCESS TO THE SETPOINTS PROGRAMMING

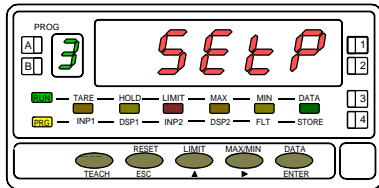

Press the **ENTER** key to move from the run mode to the programming mode. Press three times the **▶** key and press again **ENTER** to access to the programming menus. Each menu activates a different combination of the "A" and "B" LEDs. From this stage, the **▶** key permits selection of a specific menu and the **ENTER** key provides access to the programming of the parameters contained in the selected menu.

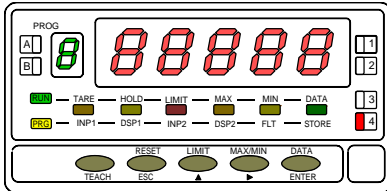

The figure shows the setpoint 1 programming step. The rest of the setpoints are programmed in the same manner, each one activating its corresponding LED. By means of the **▲** key (modify value of the active digit) and the **▶** key (advances to the next digit to the right), compose the desired setpoint value with sign between -32000 and +32000. It is not necessary to program the value of the setpoint 2 when it is going to have automatic track function, for its value will not be taken into account. Remember that, if the alarm is going to have manual track function (setpoints 2 or 4), the programmable value is not the setpoint value but the offset between this and its main alarm.

**ENTER**: Validates the programmed value and goes to the programming of the next setpoint.

**ESC**: Returns the meter to the normal operation.

# MENU 3B - OPERATION MODE CONFIGURATION

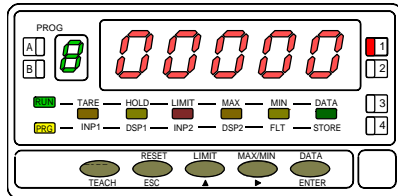
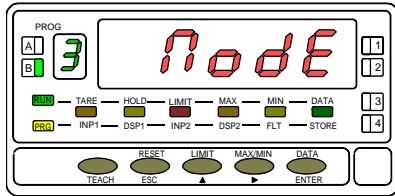

From the entry stage of the module 3 (Fig. 35.1), press the **ENTER** key to access to the menus and the **▶** key to move to the stage of entry into the menu "3B - MODE" indicated in figure 37.1. This menu allows to determine the features applied to each alarm. The "PROG" LED (programming mode indicator), "LIMIT" LED (setpoint programming indicator) and "B" LED (menu indicator) remain active during the whole phases of this menu. Press **ENTER** if you want to access this menu.

**▶**: Skips over this menu and goes to the menu 3AB for programming the delay or hysteresis levels.

**ESC**: Returns the meter to the normal operation.

The figure at left represents the first menu step corresponding to the setpoint 1 (LED 1 energized). The rest of the setpoints are accessible by pressing **ENTER** key once programmed the preceding one. Each digit represents one different operating parameter which is activated with a numbers according to the table. Starting from the left :



<u>First digit</u>	<u>Second digit</u>	<u>Third digit</u>	<u>Fourth digit</u>	<u>Fifth digit</u>
0 = OFF	0 = HI	0 = Delay	0 = Net value	0 = LED alarm
1 = ON	1 = LO	1 = Hyst_1	1 = manual Track	1 = LED alarm & display blinking.
2 = ON (latch)		2 = Hyst_2	2 = Gross value	
			3 = Peak value	
			4 = Valley value	
			5 = auto Track	

- 1<sup>st</sup> digit** : Allows disabling the setpoint "0", enabling the setpoint "1" or enabling the setpoint latch "2".
- 2<sup>nd</sup> digit** : Mode HIGH "0" or LOW "1".
- 3<sup>rd</sup> digit** : Alarm activation with time delay (DLY) "0", asymmetrical hysteresis (HYS-1) "1" or symmetrical hysteresis (HYS-2) level "2".
- 4<sup>th</sup> digit** : Activation by net value "0", by manual Track "1", by gross value "2", by peak value "3", by valley value "4" or auto Track "5".
- 5<sup>th</sup> digit** : Alarm indication by LED "0" or by LED plus display blinking "1".

**ENTER** : Validates and goes to the next setpoint configuration.

**ESC** : Returns the meter to the normal operation.

## FAST ACCESS TO THE PROGRAMMING OF THE SETPOINT VALUES

Press the "ENTER" button to move from the run to the programming mode. Press the "LIMIT" key for fast access to the programming of the setpoint values.

The previously programmed setpoint values appear on the display successively at each push of "ENTER". The setpoint number is indicated by the LED's 1, 2, 3 or 4. The LED's "PROG"(programming mode indication) and "LIMIT" (setpoint programming indication) are active during all menu steps. (See the fig. to configure the setpoint values).

Please check the lock-out programming level (see section on 'Programming lock out/Access levels', on instrument's manual). With both switches to the ON position, it is impossible to change the setpoint values but the entry to this routine remains accessible for viewing programmed data.

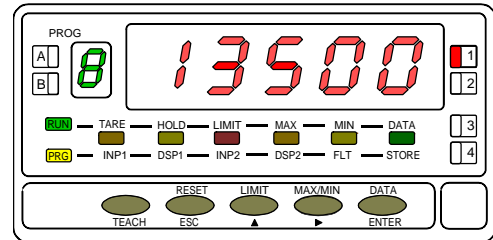

## RUN MODE INDICATIONS

The ALPHA models provide four LED's for alarm status indication. The LED's are labeled from 1 to 4 although when the 2 relay option (2RE) is installed, only the first two are used.

During the normal operation, these indicators are activated when the corresponding setpoint output goes active and, in the programming mode, they allow to identify the setpoint that is being programmed.

The programmed setpoint values (even if they are inhibited) can be viewed during the meter's normal operation by successively pressing the "LIMIT" key.

Each press of "LIMIT" causes the main display to read one of the setpoints. The setpoint number is indicated by the LED's 1, 2, 3 or 4 while the "LIMIT" LED activates for as long as the setpoints are being displayed.

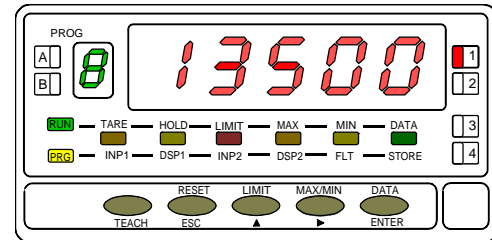

An example of what indications are present during the display of a setpoint is shown in the above figure, in this case, the SET2 is being displayed.

In case that the SET2 or SET4 alarms are configured for tracking operation, the value displayed is not the setpoint value but the offset between this and the one of their corresponding main alarm.

When positive over-range (+oUFLo) or negative over-range occurs (-oUFLo), all the outputs and LED indicators corresponding to the setpoints de-energize.

## 4.3 MODEL BETA-M SETPOINTS PROGRAMMING

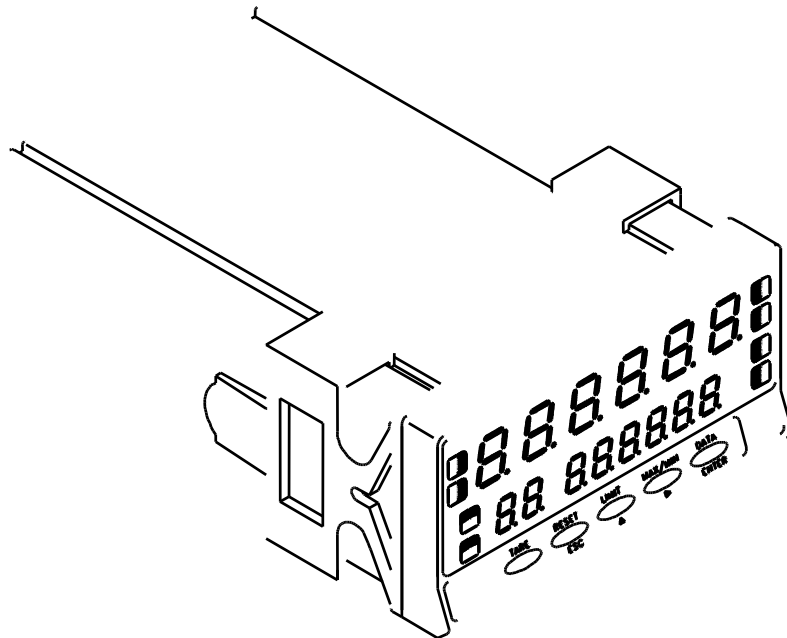

# MODEL BETA-M PROGRAMMING INSTRUCTIONS

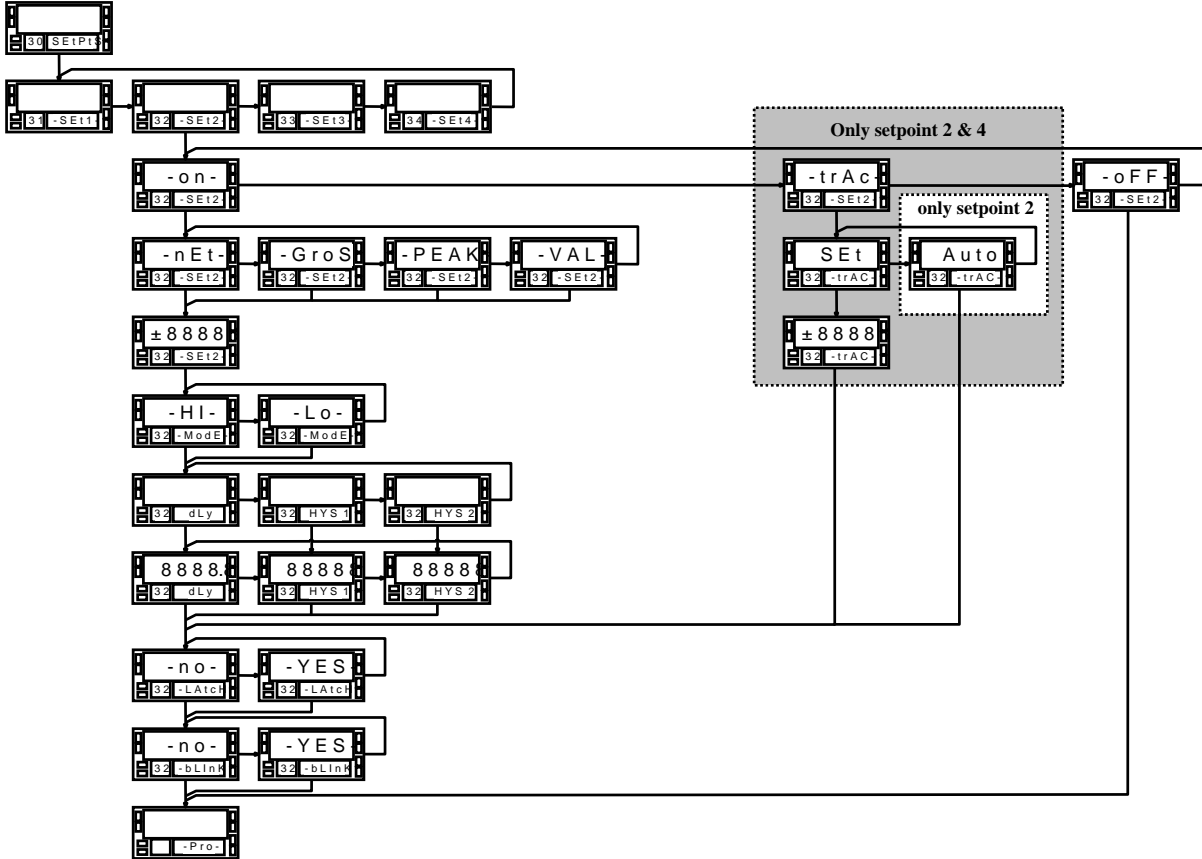



## Menu 30 - Setpoints

The diagram of page 42 corresponds to the menu 30 of setpoints programming that is valid for the output options 2RE, 4RE, 4OP y 4OPP. If you only have the output option 2 relays (2RE) it will only appear the 31 & 32 menus corresponding to the setpoints SET1 & SET2.

Each output is programmed independently by means of , finalized the programming sequence of each setpoint, by pressing the key **ENTER** the display shows the indication **"-Pro-**", wherefrom you can access to the 30 menu to configure the rest of the setpoints.

The setpoints SET1 and SET3 can only be programmed for independent action, the SET2 and SET4 can be activated independent from the first or tracking the first. In this case SET2 depends on SET1 and SET 4 depends on SET3. The setpoint 2 has automatic tracking.

The setpoint outputs can act in relationship with the net, gross, peak or valley value. There are two control modes, HI or LO, with programmable delay or hysteresis values.

The setpoints can be configured as "latch". With this configuration, the led indicator remains activated after the alarm condition has finished. The setpoint reset can only be done by means of the logical function num. 25.

It is possible to configure the display blink option when a setpoint is activated.

## Access to the setpoints programming

Press **ENTER** to go from run mode to programming mode.  
Press **▶** to pass to the level shown in the figure.

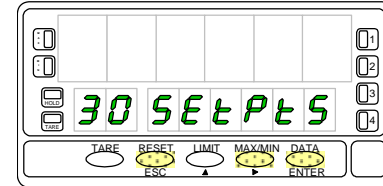

Press **ENTER** one more time and in the display will appear the indication **"31 SET-1"** corresponding to the input in the programming menu of setpoint 1. Now we are in the menu level selection, where **ENTER** allows access to the setpoints programming in the display and **▶** allows to pass to the next setpoint configuration.

## Considerations about programming instructions

Since all setpoints have the same programming sequence as free alarms (see. 44 to 47), we have changed the setpoint number in the figures by the symbol "#", this way the instructions sequence is valid for all selected number.

In the setpoints 2 and 4 programming, the selection of the **"-on-**" or **"trAC"** option (see fig. 44.2), brings you different sub-routines. Each one is explained in different sections on pages 48 and 49.

## Submenu 31, 32, 33 & 34 - SETPOINTS

### [28.1] Start

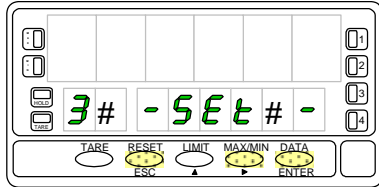

The figure shows the input display in the programming menu of one of the outputs where the symbol "#" represents the setpoint number that you are going to program. To select other setpoint, press until the desired number appears in the place of #.

- Access to the programming of the setpoint shown in display.
- Pass to the input configuration level (indication "-Pro-").

### [28.2] Setpoints Run mode

Once on the selected menu in the step before, the options represented in the figures are shown. The option "-trAC-" appears in the setpoints 2 & 4 programming menu only. By pressing , go to desired option display and press the key .

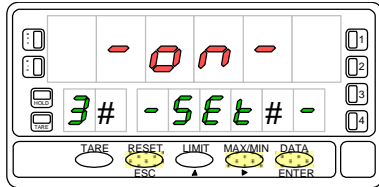

Select "-on-" to program the setpoint as independent alarm.

Press and the display shows the figure 29.1. indication.

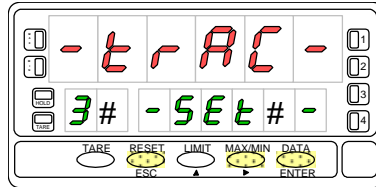

The option "-trAC-" is the tracking function that only appears in the programming menus of SET2 and SET4. Select "-trAC-" to program the setpoint as manual or automatic tracking alarm.

Press and go to page 32.

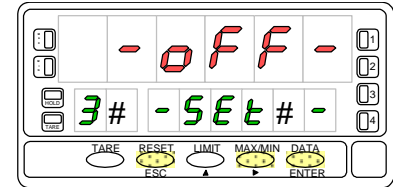

Select "-off-" to disable the action of the output relay or opto corresponding to the setpoint you are programming.

Press to go back to the "-Pro-" indication that give you access to the programming mode.

## If you have selected "-on-" in step 28.2

### [29.1] Comparison

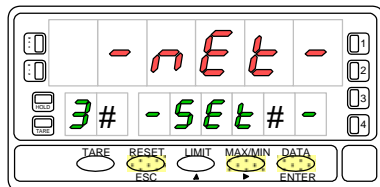

Select comparison of the setpoints with the net value **"-nEt-"**, with the gross value **"-GroS-"**, with the peak value **"-PEAK-"** or with the valley value **"-VAL-"**.

Validate the introduced data and go to introduce the setpoint value.

Return to the programming access level (indication **"-Pro-"**).

### [29.2] setpoint value

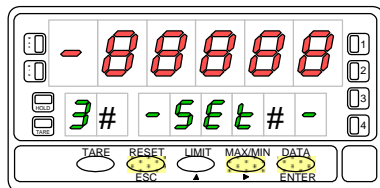

Compose using the keys and de setpoint value between "-99999" and "+99999".

Validate the introduced data and go to select the activation mode.

Return to the programming access level (indication **"-Pro-"**).

### [29.3] Activation mode

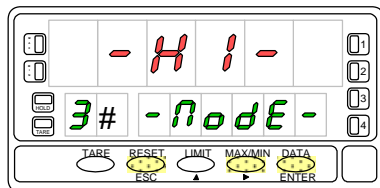

Select **"-HI-"** to activate the output over the setpoint value or **"-Lo-"** to activate the output under the setpoint value.

Validate the selection and go to the activation delay programming.

Return to the programming access level (indication **"-Pro-"**).

## If you have selected "-on-" in step 28.2

### [30.1] Activation delay

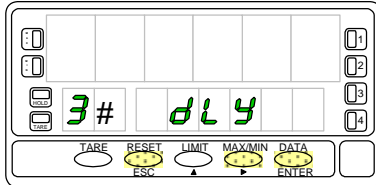

The secondary display shows three delay options in the output action. Select one of them: "dLY" = delay or "HYS 1" = asymmetrical hysteresis or "HYS 2" = symmetrical hysteresis.

Validate the selection and go to program the delay value.

Return to the programming access level (indication "-Pro-").

### [30.2] Delay value

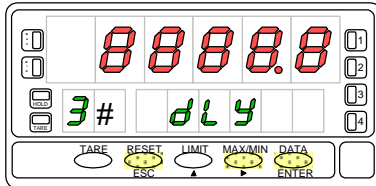

Compose using the keys and the delay value between "-9999.9" and "+9999.9" seconds.

Validate the introduced data and go to select the control mode.

Return to the programming access level (indication "-Pro-").

### [30.3] Setpoint LATCH

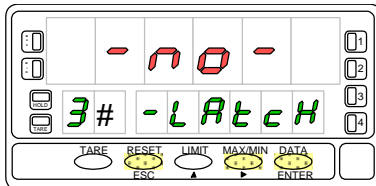

Select "-no-" or "-YES-" to configure the setpoint as "latch".

Validate the selection and go to program the blink.

Return to the programming access level (indication "-Pro-").

# If you have selected "-on-" in step 28.2

## [31.1] Blink

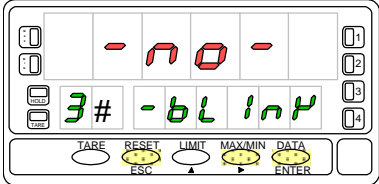

- Select "-no-" or "-YES-" to make the main display blink when the setpoint is activated.
- ENTER** Validate the selection and go to the programming access level ("-Pro-").
- ESC** Return to the programming access level (indication "-Pro-").

## If you have selected "-trAC-" in step 28.2

### [32.1] Activation mode

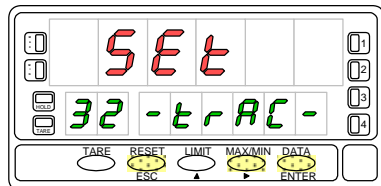

The function "-trAC-" is only available in the SET2 and SET4 alarms.

As you can see the auxiliary display shows the number 2 instead of de #; this is the only alarm that has automatic tracking, by this way, in the SET4 configuration menu, this indication is omitted and you access right to the setpoint value programming) .

In the menu 32, there are two options: manually program the tracking value from SET1 (in this case select "SET" = manual) or allow the process to select the necessary value (select "AUto" = auto)

**ENTER** If "AUto" has been selected, the ENTER key returns the instrument to the entry level in the programming mode (indication "-Pro-"). If "SET" has been selected, the ENTER key goes to the next menu step (fig. 48.2) where the SET2 or SET4 value can be programmed.

**ESC** Return to the programming access level (indication "-Pro-").

### [32.2] Setpoint value

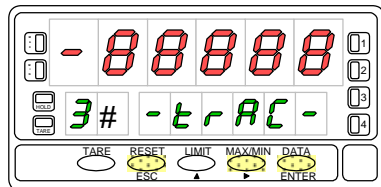

Compose using the keys **▶** and **▲** the tracking value between "-99999" and "+99999". Remember that the SET2 will track the SET1 and SET4 tracking the SET3.

**ENTER** Validate the introduced data and return to the programming access level (indication "-Pro-").

**ESC** Return to the programming access level (indication "-Pro-").

## DIRECT ACCESS TO THE SETPOINTS VALUE

There is an easy way to access only to the setpoints value configuration. From the run mode (RUN), press **ENTER**, we enter in the programming mode (PROG) and then the key **LIMIT**.

The setpoint values appears by pressing the key **ENTER**. The secondary display shows the selected setpoint. And the main display shows the setpoint value with the left digit blinking (see fig. 33.1 ). By the keys **▶** and **▲** compose the desired setpoint value, between "-99999" and "+99999".

If it is not possible to modify the setpoints value, it is because of the programming is blocked. Check the BETA-M manual for info about blocking programming.

The setpoint values can be configured if we have the connector function number 24 activated, that allows the programming and the use of the setpoints value without relay or opto output option. See the programmable functions table in the BETA-M manual.

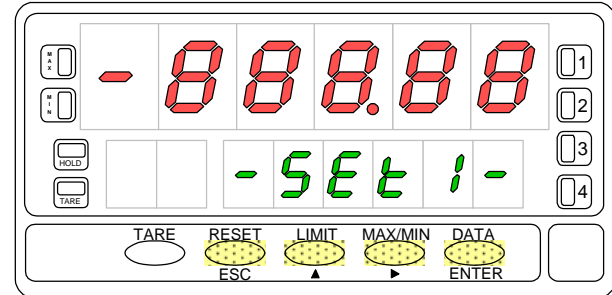

[33.1] Configuration of setpoint 1 value.

# RUN MODE INDICATIONS

The BETA-M has four LED indicators situated at the right side of the display to show the alarm status. The LEDs are numerated from 1 to 4 but with the output option 2RE, only the first two are used.

The programmed setpoint values, even if they are inactive, can be visualized during the normal device run mode by pressing the key **LIMIT**.

The visualization of any setpoint value does not affect the measure reading in the main display; the setpoint value is indicated in the secondary display while in the auxiliary appears the letter "L" followed by the number of the corresponding visualized setpoint.

In case of the setpoints SET2 and SET4, the letter "L" in the auxiliary display is changed by "t" (followed by the numbers 2 and 4) when they are tracking SET1 and SET3.

If SET2 has been programmed as auto tracking, when you recall the setpoints by pressing the key **LIMIT**, the auxiliary display and the secondary shows, in the first press, the indication "L1" and the SET1 value. The second press display the indication "t" and the tracking value. The next press shows the setpoints 3 and 4 if they are installed and finally turn off the displays.

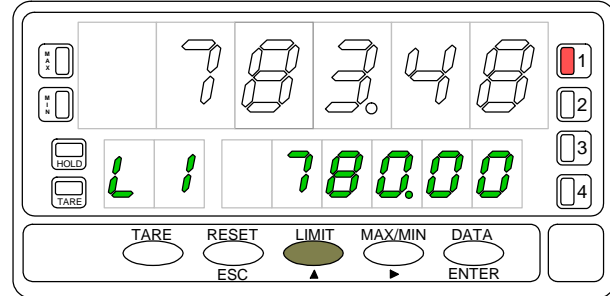

[34.1] setpoint 1 value visualization. The led 1 indicates the activation of setpoint.

The setpoint value remains in the display until a new press of key **LIMIT** is done, that shows the next setpoint value, **MAX/MIN** shows the peak value or **ENTER** that gives you access to the programming mode.

When overflow ("oUFLo"), all the output and LED indicators corresponding to the setpoints are inactive, except the ones configured as latch.











## INSTRUCTIONS FOR THE RECYCLING

This electronic instrument is covered by the **2002/96/CE** European Directive so, it is properly marked with the crossed-out wheeled bin symbol that makes reference to the selective collection for electrical and electronic equipment which indicates that at the end of its lifetime, the final user cannot dispose of it as unsorted municipal waste.

In order to protect the environment and in agreement with the European legislation regarding waste of electrical and electronic equipments from products put on the market after 13 August 2005, the user can give it back, without any cost, to the place where it was acquired to proceed to its controlled treatment and recycling.

### **DISEÑOS Y TECNOLOGIA, S.A.**

Polígono Industrial Les Guixeres

C/ Xarol 8 C

08915 BADALONA-SPAIN

Tel : +34 - 93 339 47 58

Fax : +34 - 93 490 31 45

E-mail : [dtl@ditel.es](mailto:dtl@ditel.es)

[www.ditel.es](http://www.ditel.es)